



ATZ3600EU Portable Power Station

3600W | 2048Wh

USER MANUAL

Contents

1 Important safety instructions.....	1
1.1 Safety instructions regarding risks of fire, electric shock, or personal injury.....	1
1.2 Safety instructions for operation and use.....	2
1.3 Safety instructions for movement and storage.....	3
1.4 Safety instructions for user maintenance.....	4
1.5 Safety instructions for battery use.....	4
2 Disclaimer.....	5
3 Basic information.....	6
3.1 Product overview and features.....	6
3.2 Appearance.....	7
3.3 Ambient light.....	9
3.4 LCD.....	10
3.5 Introduction of switch functions.....	13
3.6 Naming rules.....	14
4 Use the power station.....	16
4.1 External power supply.....	16
4.2 Charge the power station.....	17
4.2.1 Solar power charging.....	17
4.2.2 Car charging.....	18
4.2.3 AC charging.....	18
4.2.4 Solar plus AC simultaneous charging.....	19
4.3 Connect to secondary battery pack (Optional).....	20
4.3.1 Appearance of secondary battery pack.....	20
4.3.2 Installation of secondary battery pack.....	21

4.4 Instructions for charging scenarios.....	22
4.5 Protections for the secondary battery pack.....	24
5 Remote control of power station.....	26
5.1 Remote controller.....	26
5.2 APP remote control.....	27
5.2.1 Download the APP.....	27
5.2.2 Register and Log in the APP.....	28
5.2.3 Add the power station.....	31
5.2.4 View the power station.....	33
5.2.5 Edit the power station.....	35
5.2.6 Software update.....	35
6 Troubleshooting.....	40
7 Technical parameters.....	43
7.1 Technical parameters for main battery pack.....	43
7.2 Technical parameters for secondary battery pack.....	45

1 Important safety instructions

Please keep this manual for future reference.

This manual contains the safety, installation, and operation instructions for the ATZ3600EU series portable power station (hereinafter referred to as "power station").

Before using the power station, please read the user manual carefully to understand its operation and safety features.

Proper installation: Install the power station as per the instructions provided in the user manual. Improper installation may result in power station failure or damage.

Ventilation: Always use and store the power station in a well-ventilated place. Overheating may cause damage to the power station or fire hazard.

Exclusion of water: Do not put the power station to contact water or in a wet environment for a long time, otherwise may cause short circuit and damage to the power station.

Temperature: Do not use or store the power station in extremely hot or cold environments, otherwise may damage the battery and shorten its service life.

Handling: Handle the power station with care. Avoid dropping or impacting it.

Electrical safety: Do not attempt to disassemble, repair, or modify the power station. For any necessary maintenance, please contact our after-sales service personnel.

Charging: Only the power station can be charged within the input voltage range specified by the product. Exceeding the input voltage range may caused the damage.

Storage: If the power station has been not used for a long time, store it in a cool, dry place, and charge it every three months to keep the battery in good conditions.

Waste disposal: At the end of the service life of the power station, please dispose of it responsibly in accordance with local battery disposal regulations.

1.1 Safety instructions regarding risks of fire, electric shock, or personal injury

When using this product, always follow basic preventive measures, specifically as follows:



- Please read the instructions carefully before use.
- When using the product around children, conduct close supervision to reduce the risk of injury.
- Do not insert fingers or hands into the product.

- Using accessories not recommended or sold by our company may cause risks of fire, electric shock, or personal injury.
- To reduce the risk of damaging the power plug and power cord, unplug the plug rather than the power cord when disconnecting the power station.
- Do not use damaged or modified power station or equipment. Damaged or modified power station may exhibit unpredictable behavior, leading to risks of fire, explosion, or injury.
- Do not operate the power station with damaged wires, plugs, or output cables.
- Do not disassemble the power station. If you need maintenance or repair, please contact qualified maintenance personnel. Improper reassembly may cause risks of fire or electric shock.
- To reduce the risk of electric shock, unplug the power station from the socket before attempting any instructed repairs.
- Do not smoke or generate sparks or flames near the power station.
- When charging the built-in battery, work in a well-ventilated area and do not restrict ventilation in any way.
- Do not expose the power station to fire or high temperature. Exposure to fire or temperatures above 130°C (265°F) may cause explosion.
- Use the same parts for repair by qualified technicians, so as to ensure the safety of the product.

1.2 Safety instructions for operation and use

- Use and store the power station only in clean, dry environments. Avoid use and storage in dusty and humid environments.
- Inspect the power station before each use. Do not use if it is damaged or broken.
- If any rust, unusual odor, overheating, or other abnormalities are found in the power station, immediately stop use and contact the distributor or our after-sales service personnel.
- Ensure the power station is properly secured when being transported in a motor vehicle.
- Charge the power station only within an ambient temperature range of 4~40°C (39~104°F), and discharge within a temperature range of -20~40°C (-4~104°F).
- In the event of accidental dropping or vibration, immediately power off the power station.

- Do not use the power station if the power cord is damaged or broken.
- Keep away from children and pets. Do not allow children to use the power station.
- Do not use the power station in high-temperature areas or environments.
- If the liquid inside the power station comes into contact with your skin or clothing, rinse the affected area with tap water.
- Unplug the power cord from the socket in case of stormy weather.
- Do not place the power station on its side or upside down during use or storage.
- Do not use the accessories for any other purpose.
- Ensure the power station is powered off before connecting.
- Do not expose the power station to fire or high temperature. Exposure to fire or temperature above 130°C (265°F) may cause explosion.
- The solar charging time depends on weather conditions. Place the solar panels where it can be exposed to direct sunlight as much as possible.
- Do not quickly swing the power station at a large angle when the secondary battery is installed on the upper part of the power station. Otherwise, the secondary battery may fall.
- Do not place the power station on the floor or at a height less than 457 mm from the floor during use in repair of facilities.
- The power station is a ground device equipped with casters and tie rods. Do not place the power station higher than 10 cm. Otherwise, the damaged or explosion may occur.

 Caution	<p>Do not disassemble the power station without permission. If you need to repair the power station, please contact the local distributor or our after-sales service personnel as soon as possible.</p>
 Warning	<p>The power station is suitable for various occasions such as recreational vehicles, tents, and off-grid cabins, etc. Please make sure to follow the safety guidelines when using it outdoors. It can also serve as an emergency indoor power supply, providing reliable electricity at the crucial moment.</p>

1.3 Safety instructions for movement and storage

- Do not move the power station when it is being charged or in use.

- Do not dispose of the power station with household waste.
- Do not place the power station near a source of fire or heat, and avoid direct sunlight. Avoid direct sunlight
- Do not store the power station in a bathroom, or expose it to a rainy, or a damp environment.
- Do not disassemble the power station. If you need maintenance or repair, please contact qualified maintenance personnel. Improper reassembly may cause risks of fire or electric shock.
- Do not store the power station in high-temperature areas or environments.

1.4 Safety instructions for user maintenance

- Before use or storage, please ensure that the power station is fully charged. If the LCD displays low battery level, please promptly connect it to a power supply, such as an AC power outlet or a solar panel.
- When this product is used outdoors for a long time, please pay attention to whether the fan grids on both sides are blocked by foreign matters. If there are foreign matters, clean them up in time.

1.5 Safety instructions for battery use

- Re-placement of a battery with an incorrect type that can defeat a safeguard (for example, in the case of some lithium battery types);
- Disposal of a battery into fire or a hot oven, or mechanically crushing or cutting of a battery, that can result in an explosion;
- Leaving a battery in an extremely high temperature surrounding environment that can result in an explosion or the leakage of flammable liquid or gas;
- A battery subjected to extremely low air pressure that may result in an explosion or the leakage of flammable liquid or gas.

2 Disclaimer

The company does not assume any responsibility for damage caused by the following circumstances:

- Damage caused by improper use or use in improper working environments (it is strictly prohibited to install the power station in severe environments that are humid, high in salt spray, corrosive, greasy, flammable, explosive, or excessive in accumulation of dust).
- Damage caused by current, voltage, or power exceeding the specified limits of the power station.
- Damage caused by the working environment temperature exceeding the limited working temperature range.
- Accidents such as electrical arcs, fires, or explosions caused by failure to follow the power station markings or instructions in the manual.
- Unauthorized disassembly or repair of the power station.
- Damage caused by lightning strikes, heavy rain, floods, utility power failures or heavy force.
- Damage occurred during transportation or loading/unloading of the power station.

3 Basic information

3.1 Product overview and features

ATZ3600EU is a 3600w portable power station that integrates a variety of AC and DC output interfaces, including two 12VDC/10A cigarette lighter sockets, four USB-A interfaces (sharing a 5VDC/3A power supply for every two interfaces), two USB-C interfaces (sharing a 5VDC/3A power supply), two 100W USB-C PD interfaces, and four AC output sockets (maximum output power of 3600W) to meet the power supply needs of different AC and DC devices.

It supports four charging modes: solar charging, car charging (via the car cigarette lighter socket), AC charging, and solar + AC charging, allowing users to charge the power station in different scenarios.

The power station comes with a remote control, allowing users to remotely power off and control various switch buttons, such as powering on or off AC and DC outputs, Bluetooth, LCD screen display, and ambient light brightness. Additionally, it is equipped with a built-in Bluetooth module, enabling users to remotely monitor the operation status of the power station and adjust relevant parameters through the portable phone APP.

The device is equipped with a large-capacity lithium iron phosphate battery and supports the addition of a secondary battery pack, it is suitable for use in various occasions such as recreational vehicles, aerial photography, outdoor work, family standby electricity and other applications. It can also serve as an emergency indoor power supply, providing reliable power in critical moments.

Features

- Multiple AC and DC output ports
- Four AC outlets with a maximum power output of 3600W, peak output power up to 5400W
- Two 100W USB-C PD interfaces
- Two USB-C interfaces (sharing a 5VDC/3A power supply)
- Four USB-A interfaces (sharing a 5VDC/3A power supply for every two USB-A interfaces)
- Two 12VDC/10A cigarette lighter sockets
- 4 atmosphere light modes can be switched at will
- Energy storage lithium iron phosphate battery and intelligent BMS management, durable in use
- Support solar charging, car charging, oil engine and utility charging, to meet all kinds of charging requirements
- Super fast charging, which can charge up to 80% in as little as one hour

- Optional 2048Wh secondary battery pack available
- Equipped with a DC XT60 charging port for solar or car cigarette lighter charging
- No need for wiring between the secondary battery pack and the main unit, easy installation and disassembly
- Equipped with high-strength aluminum alloy telescopic handle and heavy-duty casters for easy mobility
- Equipped with a wireless remote control for output control and function buttons ON/OFF, and remote shutdown the device
- Built-in Bluetooth module for monitors and updating the firmware via APP
- Energy saving mode and mute charging mode are optional
- It can supply power to 99% of common electrical equipment, suitable for self-driving camping, photography aerial shooting, outdoor work, home power backup and other scenes

3.2 Appearance

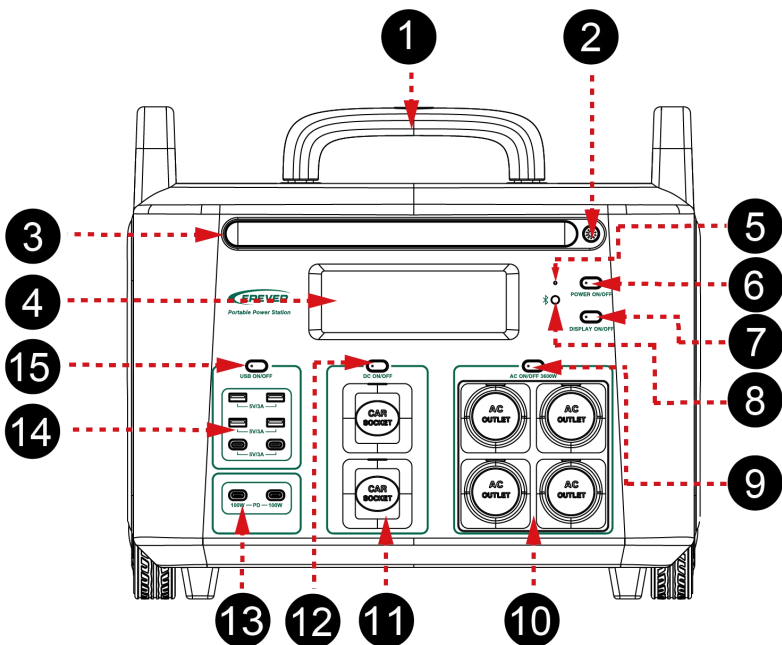

No.	Description	No.	Description
①	Telescopic handle	⑨	AC output switch
②	Ambient light switch	⑩	AC output socket * 4
③	Ambient light	⑪	Car cigarette lighter interface * 2 (12VDC/10A)
④	LCD	⑫	DC switch
⑤	Reset hole	⑬	USB-C PD interface * 2 (100W PD)
⑥	Power switch	⑭	USB-A interface * 4 (5VDC/3A) USB-C interface * 2 (5VDC/3A)
⑦	LCD display switch	⑮	USB switch
⑧	Bluetooth switch		

Note: For detailed information on the functions of switches and the reset hole, please refer to section [3.5](#)

Introduction of switch functions.

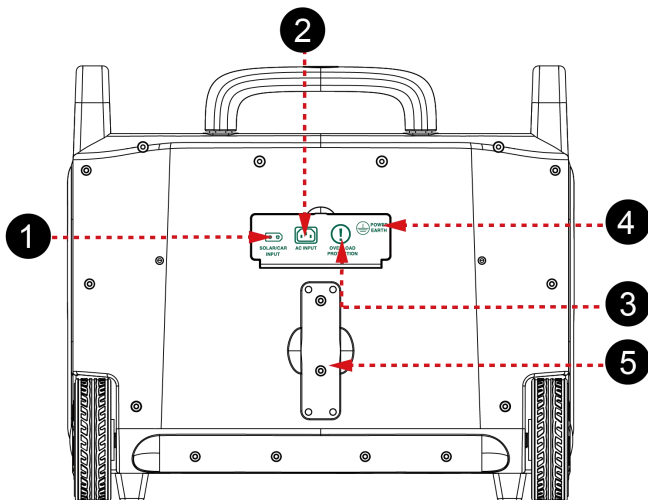

No.	Description	No.	Description
①	Solar panel/Car cigarette lighter socket charging terminal	④	Grounding sign
②	AC charging interface	⑤	Remote control holder slot
③	Overload protector		

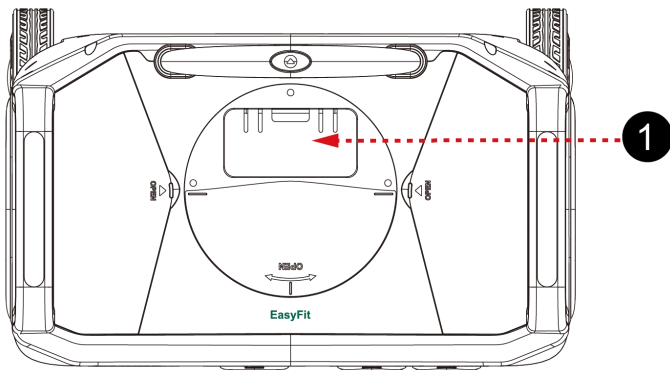

1	Connecting terminal of the secondary battery pack
----------	---

3.3 Ambient light

Ambient lighting

The first click on the ambient light switch  powers on level 3 brightness, the second click powers on level 2 brightness, the third click powers on level 1 brightness (gradual decrease in brightness), and the fourth click powers off the ambient light.

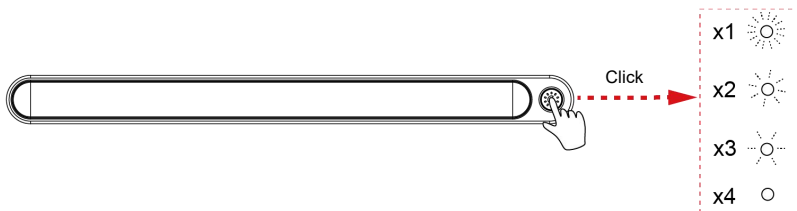

SOS mode

The ambient light starts blinking at a certain frequency by long pressing on the ambient light switch for 3 seconds  to enter SOS mode.



Note: In the SOS mode, click  to power off the ambient light.





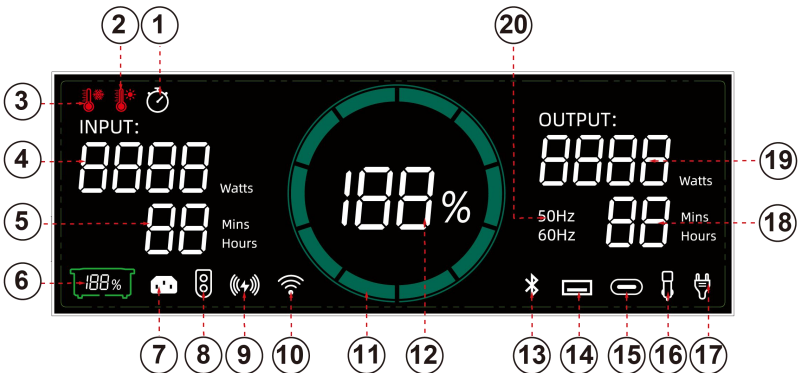

3.4 LCD

The LCD display provides real-time operating status information of the power station, including remaining battery level, output power, remaining service time, charging time, etc. It also displays the status of various functions such as USB-C, USB-A, cigarette lighter, AC input, Bluetooth, and battery station.

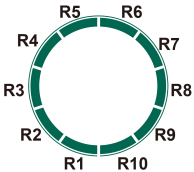

Note: The content displayed on the LCD can only be clearly viewed in the range of 90° between the horizontal line of sight and LCD. If the angle exceeds 90°, the displayed content on the LCD will not be seen clearly.







No.	Name	Functional description
①	Timing icon	Check if the APP has added a timing. The icon remains lit when the timing set in the APP is greater than zero, or powers off when the timing is set to zero.
②	High temperature warning	When either the battery temperature (read from the BMS) of the main or secondary battery pack is higher than the high temperature threshold, the high temperature warning icon lights up. When the temperature decreases, the alarm is cleared and the icon is off.
③	Low temperature warning	When either the battery temperature (read from the BMS) of the main or secondary battery pack is lower than the low temperature threshold, the low temperature warning icon lights up. When the temperature rises, the alarm is cleared and the icon is off.
④	Input power	Display the sum of DC charging power and AC input power. The icon is on with input power, and the icon is off without input power.
⑤	Remaining charging time	Display the remaining charging time. The icon lights up when the battery is charging and powers off when the battery is not charging. When the remaining charging time is less than 60 minutes, the actual minute value is displayed. When the remaining charging time is more than 60 minutes, the hour value with decimal points is displayed. When the remaining charging time is greater than 99 hours, 99 hours is displayed.
⑥	Secondary battery pack icon, secondary battery pack remaining capacity	Determine if the main battery is connected to the secondary battery pack, and shows the remaining capacity of the secondary battery pack (data should read from the secondary battery pack BMS) The icon lights up when connecting to the secondary battery pack, and powers off when the secondary battery pack is not connected.
⑦	AC input	Check the AC voltage. The icon lights up when the AC relay is connected, and powers off when the AC relay is disconnected.
⑧	DC input	The icon lights up when DC voltage input is detectable, and powers off when there is no DC voltage input.
⑨	Wireless charging	Reserved
⑩	WiFi icon	Reserved

No.	Name	Functional description
⑪	Battery level bar	<p>Display the corresponding SOC value (read from the BMS module).</p> <p>The icon is lit when the device is powered on and goes out when the device is powered off.</p> <p>The starting point is bottom-left R1, corresponding to 0—10% battery level; R2 corresponds to 11—20% battery level; and so on until R10 corresponds to 91—100% battery level.</p> <p>Note: The Battery level bar blinks when charging, and it will decrease as the remaining amount of electricity during discharging.</p> 
⑫	Remaining battery level	<p>Display the percentage value of SOC (read from the BMS module). The icon is lit when the device is powered on and goes out when the device is powered off.</p>
⑬	Bluetooth icon	<p>Check the output status of the Bluetooth button. The icon is lit after pressing  , and powers off after pressing  again.</p>
⑭	USB-A, USB-C icon	<p>Check the output status of the USB switch. The icon is lit after pressing  , and powers off after pressing  again.</p>
⑮	USB-C PD icon	<p>The icon is lit when there is a device connecting to the USB-C PD interface, and goes out when the device is disconnected from the USB-C PD interface.</p>
⑯	Cigarette lighter icon	<p>Check the output status of the DC switch.</p> <p>The icon is lit after pressing  , and powers off after pressing  again.</p>
⑰	AC output	<p>Check the status of the load output relay. The icon is lit when the load output relay is connected, and powers off when the load output relay is disconnected.</p> <p>Note: When the icon blinks, the device is in the overload lock state. You need to restart the device to resume normal work.</p>
⑱	Remaining battery runtime	<p>Show the remaining service time (battery life). The icon lights up when the battery is discharging and powers off when the battery is not discharging. If the remaining runtime is less than 60 minutes, the actual minutes are displayed. When the remaining runtime is more than 60 minutes, the hour value with decimal points is displayed. If the remaining runtime is greater than 99 hours, 99 hours is displayed.</p>

No.	Name	Functional description
19	Output power	Display the sum of AC load power and DC output power. The icon is on with output power, and the icon is off without output power. Note: DC output power is not displayed if it is less than 3W, and AC output power is not displayed if it is less than 30W.
20	Frequency	Check if there is AC input or output. If the AC input or output is present, it displays the AC output frequency (50 Hz is displayed for a range of 40 – 55 Hz, and 60 Hz is displayed for a range of 56 – 70 Hz). The icon powers off when there is no AC output and input.

Note: The LCD for software updating, please refer to chapter [5.2.6 Software update](#).

3.5 Introduction of switch functions

No.	Switch diagram	Switch name	Functional description
1		Power switch	Output switch of battery BMS board. Long press for 3 seconds to power on, and long press for another 3 seconds to power off.
2		Display switch	Control the LCD backlight. Press to power on, press again to power off. Note: After the screen lights up, the initial 100 seconds are set at high brightness, followed by 20 seconds at low brightness. It will automatically power off after 120 seconds of no operation, and will reset the timer with any operation.
3		USB switch	Control outputs of USB-A and USB-C. Press to turn on the USB output, and press again to clear the fault or turn off the USB output.
4		DC switch	Control output of cigarette lighter. Press to turn on the DC output, and press again to clear the fault or turn off the DC output.
5		AC switch	Control AC output. Press to turn on the AC output, press again to turn off the AC output.
6		Ambient light switch	The first click powers on 3-level brightness, the second click powers on 2-level brightness, the third click powers on 1-level brightness, and the fourth click powers off the ambient light. Long press for 3 seconds to enter SOS mode (the ambient light will blink at a certain frequency).

No.	Switch diagram	Switch name	Functional description
7		Bluetooth switch	Activate Bluetooth. Press to power on, press again to power off. After turning on the Bluetooth switch, long press to unbind the device. Note: The wireless technology testing frequency and power is 2402MHz to 2480MHz @ 1.84 dBm.
8		Reset hole	Located above the Bluetooth switch, press for soft reset of device information.
9		AC switch + DC switch	First press the AC switch to power on the frequency display, and then press the AC switch and DC switch simultaneously to switch the AC output frequency.
10		USB switch + DC switch	Power off the buzzer. And power on the buzzer via the APP, refer to chapter 5.2.4 View the power station for detail.

3.6 Naming rules

- Naming rules for main battery pack

ATZ 3600 EU



- Naming rules for secondary battery pack

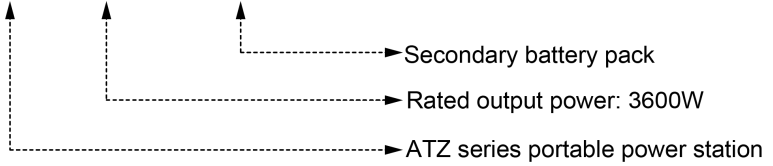

ATZ 3600 - BATT





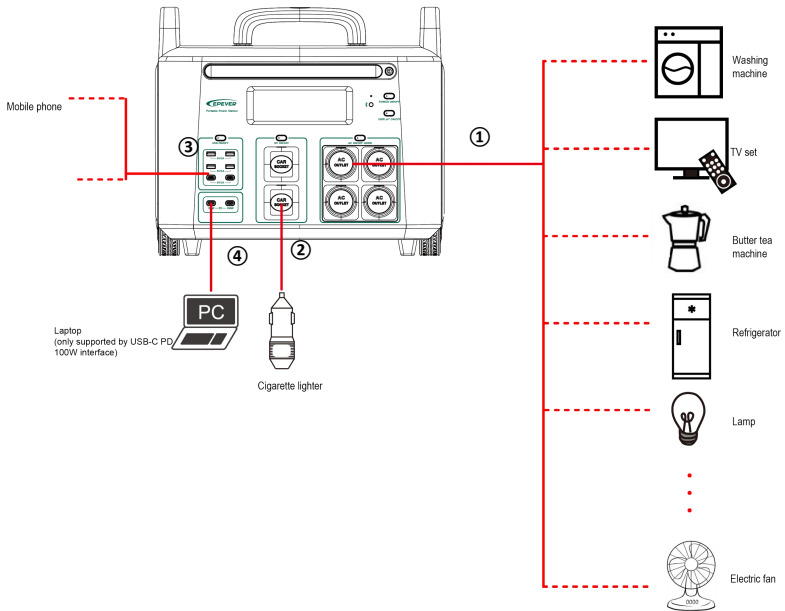



4 Use the power station



4.1 External power supply



① **AC output:** Short press  to power on the AC output, the AC load icon  will light up after about 5 seconds. Short press the switch again to power off the AC output, the AC load icon  will go out within 5 seconds.

② **DC output:** Short press  to power on the DC output, the cigarette lighter icon  will light up. Short press the switch again to power off the DC output, the cigarette lighter icon  will go out within 1 to 2 seconds.

③ **USB-A and USB-C output:** Short press  to power on the USB-A and USB-C output, the USB-A icon  will light up. Short press the switch again to power off the USB-A and USB-C output, the USB-A icon  will go out.

④ **USB-C PD output:** When the USB-C PD interface is connected to a device, the USB-C PD output will be powered on automatically, and the USB-C PD icon  will light up. Disconnect the device to power off the USB-C PD output, the USB-C PD icon  will go out.

Note: When the DC or AC output power is higher than the minimum measurable value, the "OUTPUT" icon and output power  will be displayed on the right side of the LCD.

4.2 Charge the power station

This power station supports four charging modes: solar charging, car charging (car cigarette lighter socket charging), AC charging, solar plus AC simultaneous charging.

Note: The power station will be activated directly for charging when the AC or DC power is connected.

- This product supports individual DC charging, individual AC separate, or DC plus AC simultaneous charging.
- When there is charging power, the display will display INPUT and charging power .
- During the charging process, the SOC battery bar on the LCD flashes to display the battery capacity in real time.

4.2.1 Solar power charging

This power station does not have a limit on the power of solar panels connected, it requires at least one solar panel for charging, and the minimum input voltage is 11VDC. If only one solar panel is connected, you can directly connect the solar panel to the SOLAR/CAR INPUT port of the power station for charging through the PV charging cable attached to the package.

If several solar panels are connected in series or parallel, it is necessary to ensure that the maximum open circuit voltage of PV is not greater than 60VDC at the lowest temperature (the maximum charging power of PV is 1200W, and it can be selected in series or parallel according to the voltage and power of each solar panel). Please connect the solar panels in series or parallel first, and then connect them to the power station for charging.

Note: The connector for solar series or parallel connection is not included, and is purchased separately. Please read the detailed operating instructions of the solar connector before use. Ensure correct positive and negative polarity, and do not connect them in reverse.

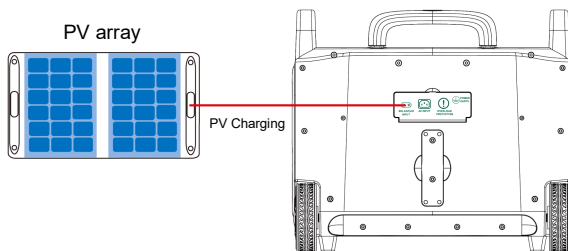

Solar charging time: (1200W input power) it takes **1.7** hours to fully charge the main battery pack.

4.2.2 Car charging

Note: Solar charging and car charging, only one of the two can be used, simultaneous use is not permitted.

Connect the SOLAR/CAR INPUT port of the power station to the car cigarette lighter socket via the supplied car charging cable to charge the power station.

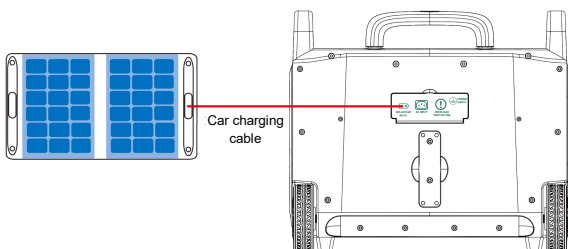

Car cigarette lighter socket charging time: it takes **17** hours to fully charge the main battery pack.

4.2.3 AC charging

Please use the AC charging cable supplied in the package to connect the AC INPUT port of the power station and the AC socket in the wall for charging.

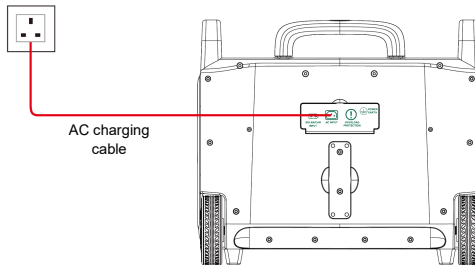

AC charging time: it takes 1.2 hours to fully charge the main battery pack.

4.2.4 Solar plus AC simultaneous charging

When AC charging and solar charging are enabled at the same time, the product will give priority to solar charging and use the two methods at the same time to charge the battery at the maximum allowable power.

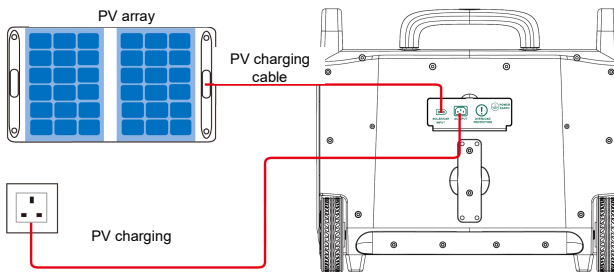

AC charging plus the maximum PV charging time: It can only charge the main battery pack at the same time, and it takes 1.2 hours to fully charge.

4.3 Connect to secondary battery pack (Optional)

4.3.1 Appearance of secondary battery pack

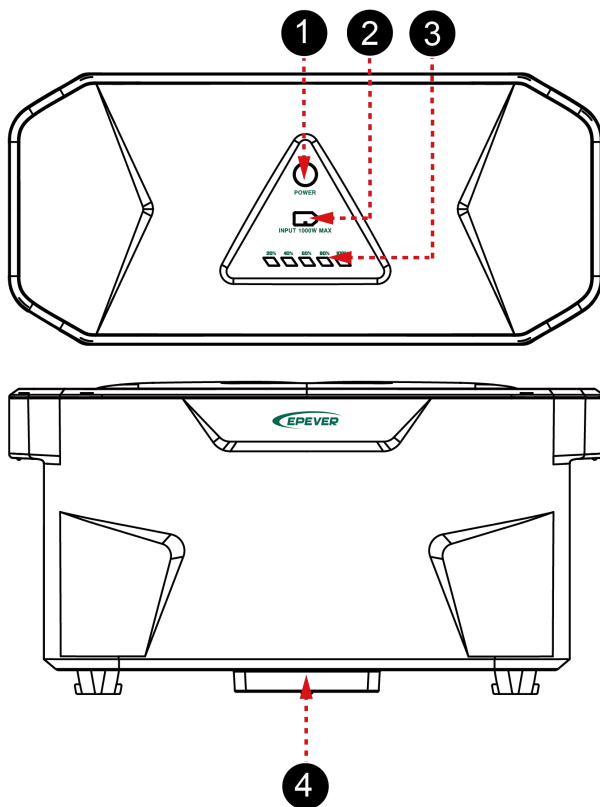

No.	Description	No.	Description
1	Power button ⁽¹⁾	3	Capacity indicator light
2	Solar panel/Car cigarette lighter socket charging terminal	4	Connecting terminal (connected to main battery pack)

(1) Operation instructions for the power button of the secondary battery pack:

Press for 1 second: The capacity indicator light is on solid, and the secondary battery pack is powered on.

Press for 3 seconds: The tail light of the capacity indicator flashes, it means the secondary battery pack turns on the charging and discharging.

Press for 5 seconds: The secondary battery pack turns off the charging and discharging, and later shuts down the secondary battery pack (the secondary battery pack is not connected to the main battery pack).

4.3.2 Installation of secondary battery pack

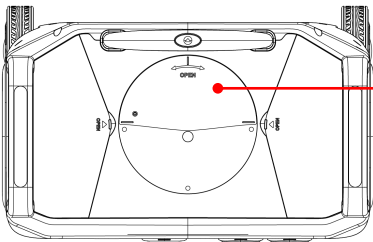

Step 1: Remove the fixing screws of the cover plate on the top, and move the cover plates left and right to expose the connecting terminals.

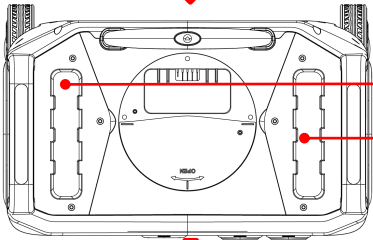

Step 2: Remove the cover plates on the left and right sides of the portable power station.

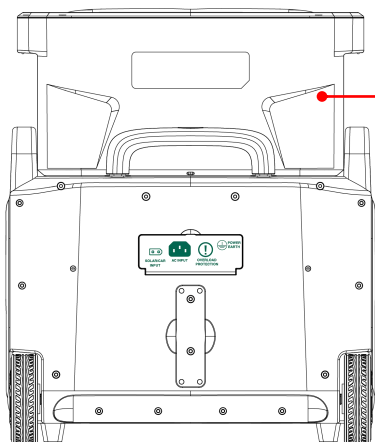

Step 3: Put the secondary battery pack into the slots on both sides of the portable power station and push it backward to clamp it tightly.

Note: The protective cover of the secondary battery pack must be removed before connecting.



CAUTION

After installing the secondary battery pack, the portable power station must not be moved or swung significantly. Otherwise, there is a risk of the secondary battery pack falling!

4.4 Instructions for charging scenarios

- Charging the secondary battery pack

No.	Applicable scenarios	Instructions
1	The secondary battery pack is not connected to the main battery pack.	The secondary battery pack can be connected to PV panels for independent charging.
2	After the secondary battery pack is connected to the main battery pack, there is only one set of PV panel.	It is recommended that this set of the PV panels be connected to the main battery pack for charging first. When the main battery pack is fully charged, the PV panel will not charge the secondary battery pack. If you need to charge to the secondary battery pack, disconnect the PV panel and the main battery pack, and turn off the main battery pack. And then connect the PV panel to the secondary battery pack for charging independently. Note: The main battery pack cannot be powered on in the current state, otherwise the charging process of the secondary battery pack will be stopped.

No.	Applicable scenarios	Instructions
3	After the secondary battery pack is connected to the main battery pack, there are two sets of PV panel.	Disconnect the secondary battery pack from the main battery pack and separately connect each to a PV panel for charging.
4	After the secondary battery pack is connected to the main battery pack, there is AC connected.	The AC power is preferred for charging the main battery pack. Once the main battery pack is fully charged, the AC power will automatically charging the secondary battery pack. Note: During the charging process of the secondary battery pack, do not connect the PV panels, as this will interrupt the charging.

● **Charging the main battery pack**

No.	Applicable scenarios	Instructions
1	When the secondary battery pack is connected to the main battery pack, and it needs to charge the main battery pack.	<ul style="list-style-type: none"> ➢ If you need the secondary battery pack charging to the main battery pack, power on the main battery pack first, and press the power button of the secondary battery pack within 10 seconds to charging the main battery pack; ➢ Or press the power button of the secondary battery pack for 3 seconds to turn on the discharging, and then power on the main battery pack, and the secondary battery pack will charging the main battery pack. <p>Note: The secondary battery pack cannot turn on the charging and discharging automatically, you must manually press the power button of the secondary battery pack for 3 seconds to turn on the charging and discharging.</p> <p>If the PV panels or AC power is connected to the main battery pack before the secondary battery pack was connected, the secondary battery pack will not charge the main battery pack.</p>
2	When the main battery pack supplies power to the load, the secondary battery pack must supply power at the same time.	Press the power button of the secondary battery pack for 3 seconds to turn on the discharging.

No.	Applicable scenarios	Instructions
3	After the secondary battery pack is connected to the main battery pack, the AC and the PV panel are simultaneously connected to the main battery pack.	The AC and PV panels are preferred to charging the main battery pack until the main battery pack is fully charged. If you need to charge the secondary battery pack, disconnect the PV panel first.
4	In the process of secondary battery pack charging the main battery pack.	<ul style="list-style-type: none"> ➢ Don't set the charging mode in the APP as "Standard (mute charge)," to set the standard charge mode is invalid operation. ➢ Do not power off the main battery pack directly or power it off by remote Control/ APP. First press the power button on the secondary battery for 5 seconds to turn off the discharging, and then power off the main battery pack.
5	In the process of charging the main battery pack, the AC power or PV panel is connected to the main battery pack.	<p>The secondary battery pack stop charging the main battery pack, the AC power or PV panel is preferred to charging the main battery pack.</p> <p>Note: The AC power and PV panel can charge the main battery pack at the same time. If you want to power off the main battery pack during charging, you need to disconnect the AC or PV panels.</p>

4.5 Protections for the secondary battery pack

No.	Applicable scenarios	Instructions
1	During the charging and discharging process of the secondary battery pack, the temperature of DC/DC module on the main board is too high.	At this time, the secondary battery pack is activated by over-temperature protection and automatic turn off the charging and discharging. After the temperature drops, the charging and discharging will recover automatic.
2	During the charging process from the secondary battery pack to the main battery pack, the AC output power is too high and loads are turned on/off frequently.	At this time, the secondary battery pack is prone to over-power protection. Press the power button of the secondary battery pack for 5 seconds to power off the discharging. In the event that the secondary battery pack's power button fails to reset after an over-power protection occurs, the secondary battery pack will automatically resume discharging after approximately 10 minutes.

No.	Applicable scenarios	Instructions
3	<p>During the charging process from the secondary battery pack to the main battery pack, the secondary battery pack may trigger a high temperature or low temperature protection.</p>	<p>The secondary battery pack will automatically turn off the discharging. After the temperature of the secondary battery pack decreases or rises, manually press and hold the secondary battery pack's power button for 3 seconds to initiate discharging, and then recharge the main battery pack.</p>
4	<p>During the process of AC charging the secondary battery pack, the secondary battery pack is protected by high temperature or low temperature.</p>	<p>At this time, even if the temperature decreases or increases, the secondary battery pack will not automatically resume charging. It is necessary to first disconnect from the AC power, turn off the main battery pack. Subsequently, upon re-establishing the AC connection, the main and secondary battery packs will be automatically activated, allowing for the recharging to the secondary battery pack.</p>

5 Remote control of power station

5.1 Remote controller

ATZ3600EU power station is equipped with a remote controller. The remote controller's buttons are introduced as follows:



Button name	Functional description
Power button	Press the button to power off (the remote controller can be only used for powering off, and not for powering on; the device can be powered on through the power switch of the device).
LCD display button	Press the button to power on LCD screen, and press it again to power off the LCD screen.
DC output switch	Press the button to turn on the cigarette lighter output, and press it again to clear the fault or turn off the output.
AC output switch	Press the button to turn on the AC output, and press it again to turn off the output.
Bluetooth communication switch	Press the button to turn on the Bluetooth communication, and press it again to turn off the Bluetooth communication.
USB switch	Press the button to turn on the USB-A and USB-C output, and press it again to clear the fault or turn off the output.
Ambient light switch	The first click turns on level 3 brightness, the second click turns on level 2 brightness, the third click turns on level 1 brightness, and the fourth click turns off the ambient light. Long press the switch for 3 seconds to enter the SOS mode.

Remote Controller specification:

Name	Value	Name	Value
Working voltage	12VDC	Modulation method	amplitude modulation
Working current	≤15mA	Encoding chip: fixed code	Encoding chip: fixed code
Working frequency	433.92MHz	Battery	23A/12VDC
Transmission power	-40.35dBm	Number of buttons	7 keys
Launch distance	40 –80 meters (Open environment)	Shell material	ABS plus iron sheet plus silicone
Transmission rate	1–5KHZ	Product size	120mm x 31mm x 13.5mm
Frequency deviation	±0.2MHz	--	--

5.2 APP remote control

You can view the power station information, update the software version, monitor the working status and personalize the settings through the APP.

5.2.1 Download the APP

Use the default browser of the mobile phone to scan the following QR code to download the APP installation package, and successfully install it on the mobile phone.



5.2.2 Register and Log in the APP

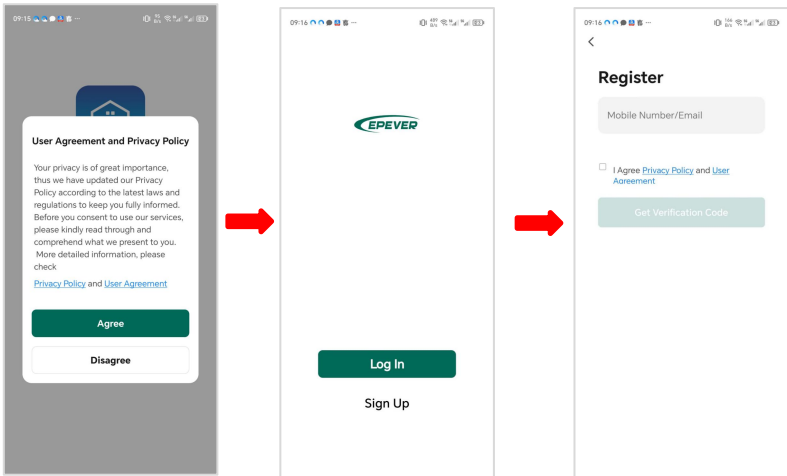

1. After the APP is downloaded and installed, open the APP and click "Agree" to agree the User Agreement and Privacy Policy.

2. For the first time, click "Sign Up" to enter the registration screen. If you already have an account, click "Log In."

3. On the "Register" screen, enter your mobile phone number or email address, and click "Get Verification Code."

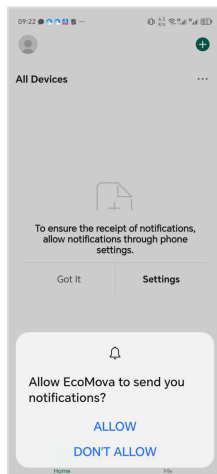
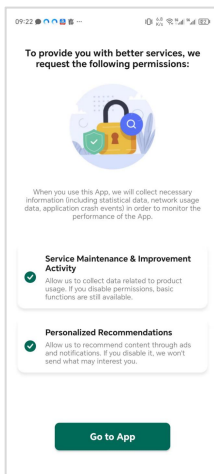
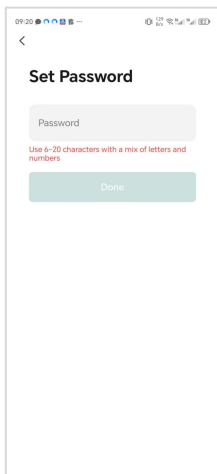

<p>4. Enter the received verification code to enter the password setting screen, set the password of the new account, and click "Done."</p>	<p>5. After the account registration is successful, click "Go to App."</p>	<p>6. In the next screens, set whether to allow the APP to send notifications, enable the notification bar permission of the APP, and enable the location permission of the APP.</p>
---	--	--

<p>Warning</p>	<p>Location permissions must be enabled during the APP running process. If the location is disabled, the devices cannot be added into the APP.</p>
-----------------------	--

If the location permission is not enabled during account registration, you can perform the following operations to enable it.

Method 1: Click "Settings > Apps > Apps" on the mobile phone, find the "EcoMova" APP, and enable the location permission according to the following flow chart.

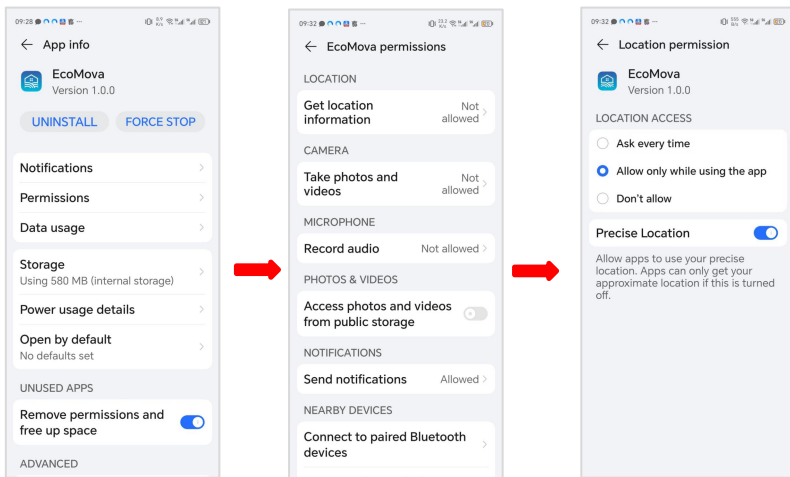



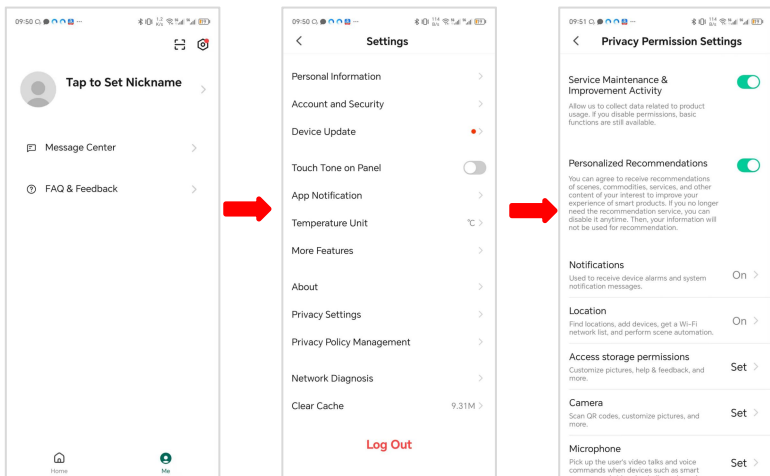

- | | | |
|-------------------------|--------------------------------------|---|
| 1. Click "Permissions". | 2. Click "Get location information." | 3. Set location permission to "Allow only while using the app." |
|-------------------------|--------------------------------------|---|

Method 2: In the "Me" screen of the "EcoMova" APP, click  in the upper right corner to enter the "Settings" screen. And click "Privacy Settings > Location" to enter the "App info" screen, as shown in Method 1. Enable the location permission of the APP.



Note: The red dot on the icon  indicates that a newer software version is available.

5.2.3 Add the power station

 <p>Warning</p>	<p>Before adding the power station, you must click the Bluetooth switch   to enable the Bluetooth function, turn on the Bluetooth and location information of the mobile phone, and enable the location permission of the APP. Otherwise, the power station cannot be added successfully.</p> <p>If you cannot search a nearby power station, it is possible that this power station has been bound to other mobile phones. You need to long press the Bluetooth switch   to unbind the power station under the Bluetooth switch is turned on.</p>
---	--

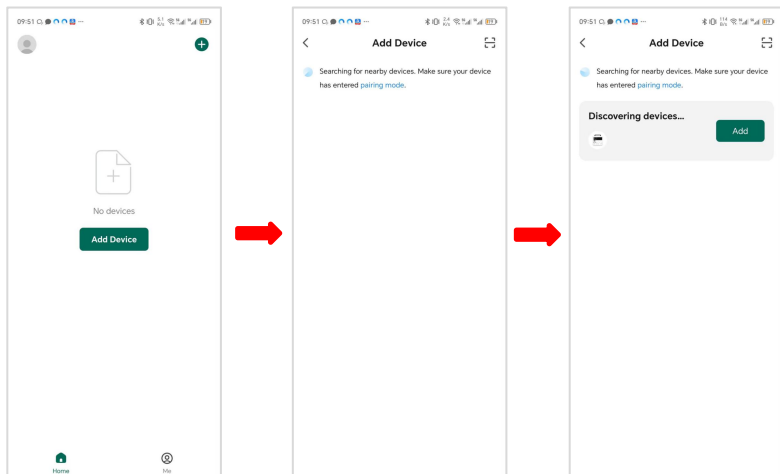

- | | | |
|--|--|---|
| <p>1. On the main screen, click "Add Device" or  in the upper right corner.</p> | <p>2. Enter the "Add Device" screen, the available power stations nearby is searched automatically.</p> <p>Note: It is a must to turn on the Bluetooth function and location permission. otherwise the power station cannot be searched.</p> | <p>3. Click "Add" to start the adding process of the power station.</p> |
|--|--|---|

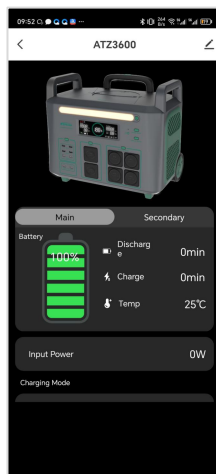
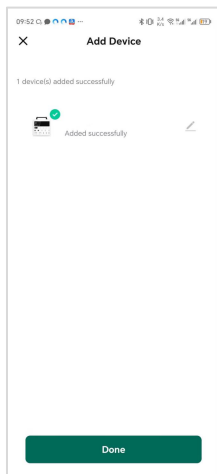
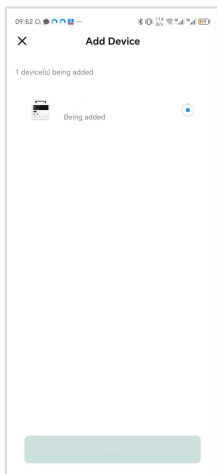

4. Adding the power station

5. Click "Done" to finish.

6. Enter the home screen of the power station for viewing information and setting related functions.

5.2.4 View the power station

After the power station is successfully connected, enter the following APP main screen.

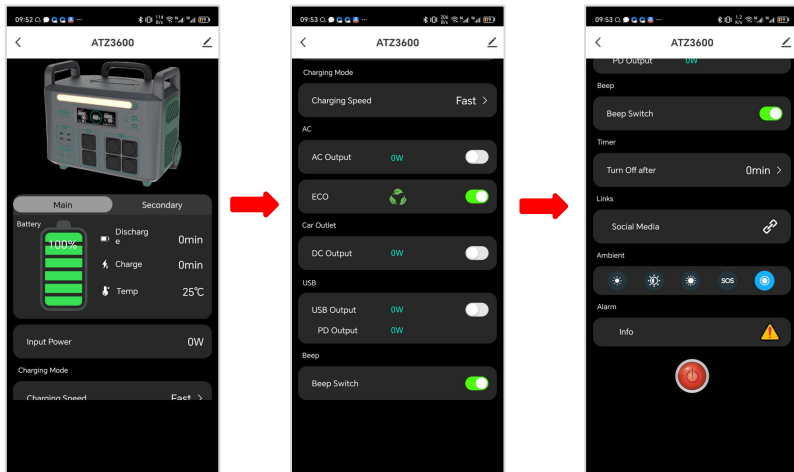



Parameter	Parameter specification
Main battery pack/ Secondary battery pack	Click "Main" and "Secondary" to view relevant information of the main battery pack and secondary battery pack. Note: Only when the secondary battery pack is connected, click "Secondary" will display the information about the secondary battery pack.
Battery	Main battery information or secondary battery information, including discharge remaining time, charge remaining time, and battery temperature.
Input power	Display the sum of DC input and AC input power.
Charging mode	Standard (mute charge/ the charging power is about 600W in the Standard mode/ normally, the fan does not start for a long time, and there is no noise.) Fast (normal charge, 2000W at most.)
AC output	Turn on or off the AC output. The AC output power will display after turning on the button.
ECO	Turn on or off the energy saving mode (the "ECO" is enabled by default after the power station is powered on). Turn on: The AC load power, upon continuously operating below 22W for 8 hours, will automatically shut off. Turn off: The AC output will never be closed automatically after it is opened.

Parameter	Parameter specification
DC output	Turn on or off the cigarette lighter output. The DC output power will display after turning on the button.
USB output	Turn on or off the USB output. The USB output power will display after turning on the button. The PD output power will display automatically when the PD interface is connected to a device.
Beep switch	Turn on or off the beep. Turn on: There will be a buzzer remind when operating the power station.
Timer	Set the device shutdown time, the set range is 1—255 minutes. Upon expiration of the set time, the power station will automatically shutdown. When there is AC and DC input, or the secondary battery pack charging the main battery pack, the timing is invalid. When set to 0, cancel the timing. Note: Remote shutdown via the APP is possible, but remote startup is not supported. To power on the power station, the physical power switch must be used.
Web links	Click to select the web links (currently support Facebook and Twitter), and automatically jump to the corresponding site.
Ambient light	It is the brightness of level 1, level 2, level 3, the SOS mode, and close the ambient light from left to right.
Alarm	Click to display all abnormal information that occurred during the connection between the power station and the APP. Note: The abnormal information that occurs when the power station is not connected to the APP will not be saved by the APP.
Power off	Click this button to power off the power station. After the power station is powered off, it must be manually powered on via the power switch.

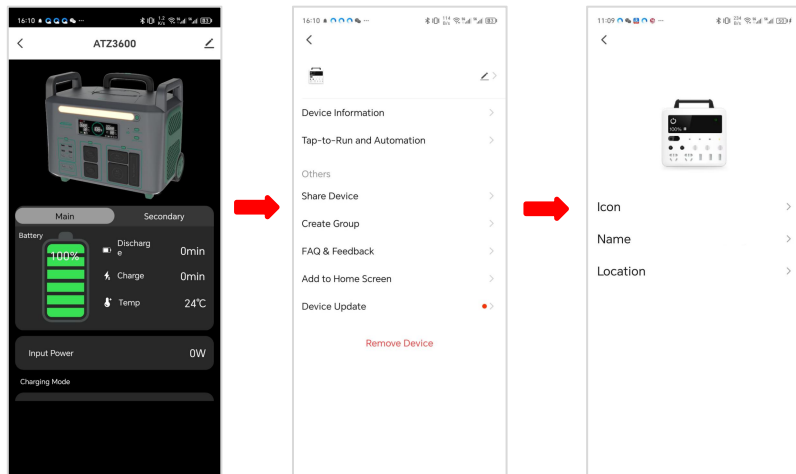
5.2.5 Edit the power station



1. On the power station screen, click the icon  in the upper right corner.	2. Enter the device editing screen and click the icon  after the device name.	3. Modify the device icon, name, and location information.
---	--	--

Note: On the device editing screen, you can also update the device or remove the device etc.

5.2.6 Software update

Click the edit icon  in the upper right corner > click "Device Update"> click "Update" to perform firmware update after entering the APP main screen.

 Warning	<ul style="list-style-type: none">• Before updating the device, please disconnect the main battery pack and the secondary battery pack, otherwise the device may be powered off after the failure of updating.• When the battery capacity drops to or below 5%, the system prohibits software upgrades. And the upgrade failure will be prompted after click "Update" on the APP.
---	--

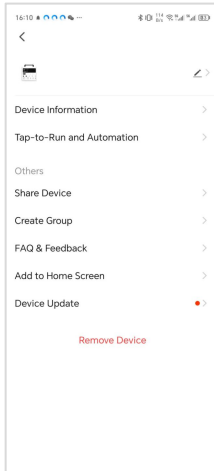

Click "Start update" to upgrade the software. Upon completion, the system will automatically return to the device editing screen, displaying "Latest version."

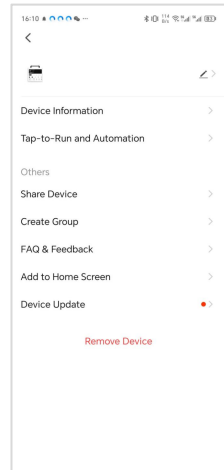
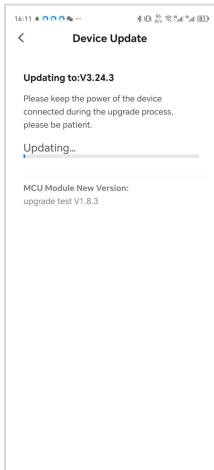
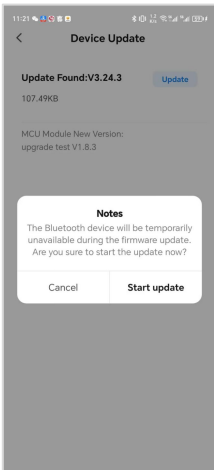

During the process of software upgrading, the LCD displays 2000, which indicates the update of the OTA.

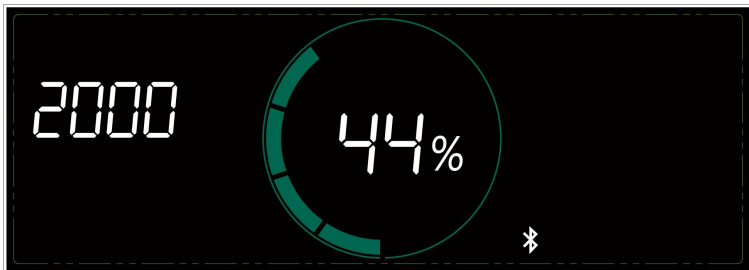

After the software download is completed, the LCD screen of the power station will turn off, accompanied by the blinking of the indicator on the  switch. Approximately 30 seconds later, the LCD screen will light up again, indicating the software upgrade is completed.

Note: When upgrading the software, check whether the following conditions are met; otherwise, the upgrade may fail.

- 1) Ensure a reliable Bluetooth connection between the power station and the APP.
- 2) Ensure the mobile phone is closely positioned to the power station, and keep the current APP upgrade screen still. Do not switch the APP to the background of the phone.
- 3) Ensure a strong internet signal on your mobile phone.

If the upgrade fails, the Bluetooth connection between the power station and the APP will be disconnected. You need to return to the APP main screen to reconnect the power station and continue to upgrade.

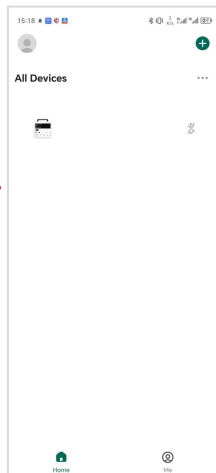
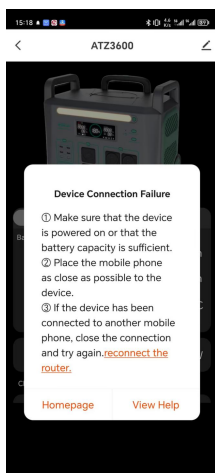
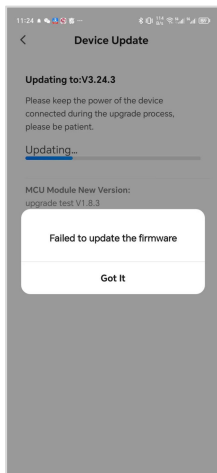

<p>1. If the upgrade fails, click the "Got it" to exit the current screen. Note: You can't click "Update" directly on this screen, otherwise it will not be successful.</p>	<p>2. Return to the APP main screen, a "Device Connection Failure" prompt message appears. Click "Homepage."</p>	<p>3. Enter the device reconnecting screen, click the Bluetooth icon, the device and APP automatically reconnect.</p>
--	--	---

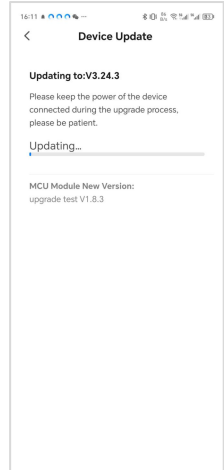
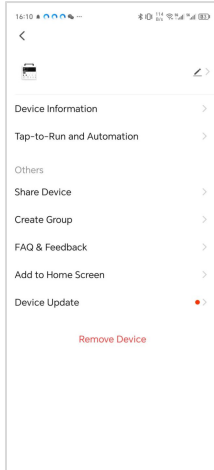
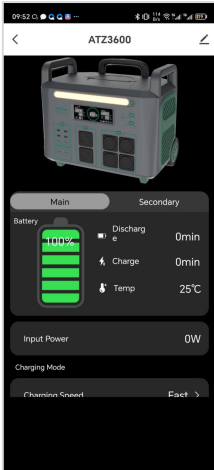









4. After the device is successfully reconnected, return to APP main screen automatically. Click the  in the upper right corner.



5. Re-enter the device editing screen and click "Device Update" again.

6. Automatically continue the last updated until it updating successfully.

6 Troubleshooting

No.	Problem	Abnormal phenomenon	Solution
1	DC Input Overvoltage		Unplug the DC input plug, and measure whether the DC input voltage exceeds 62VDC.
2	DC Input Undervoltage		The power station stops charging. The failure content is reported to APP.
3	AC Input Overvoltage		You can click "Alarm > Info" on the APP to view the specific fault content.
4	AC Input Undervoltage		
5	USB Overload	The corresponding output port stops discharging. The failure content is reported to APP. You can click "Alarm > Info" on the APP to view the specific fault content.	Remove the abnormal load, and press the button  to restore output. Note: Each USB port is powered individually, and USB overload will only shut down the output of the respective port.
6	Cigarette Lighter Socket Overload		Remove the abnormal load, and press the button  to restore output.
7	Cigarette Lighter Output Short Circuit		Disconnect the short-circuit device, and press the button  to restore output.
8	PD Overload		Remove the abnormal device, re-plug the device and restore output.

No.	Problem	Abnormal phenomenon	Solution
9	AC Output Overload	The AC output is turned off after the fault occurs, and the corresponding icon on the LCD disappears. The failure content is reported to APP. You can click "Alarm > Info" on the APP to view the specific fault content.	Remove the overpower device, and reduce devices used in the output ports. Electrical appliances must be used within the rated power. When there is AC input, the output load is limited to be smaller than 2000W.
10	AC Output Overload Lockout	The AC output is turned off after the fault occurs, and the corresponding icon on the LCD disappears. The failure content is reported to APP. You can click "Alarm > Info" on the APP to view the specific fault content.	Restart the power station and press the button  to restore output.
11	Main Battery High Temperature	LCD displays the high temperature alarm icon  . With 3 warning	Wait for the main battery pack to cool down, and resume charging only after the  icon appears.
12	Extra Battery High Temperature	alerts, charging will be stopped.	Wait for the secondary battery pack to cool down, and resume charging only after the  icon appears.
13	Main Battery Low Temperature	LCD displays the low temperature alarm icon  . With 3 warning alerts, charging will be stopped.	Wait for the main battery pack to heat up, and resume charging only after the  icon appears.

No.	Problem	Abnormal phenomenon	Solution
14	Extra Battery Low Temperature	LCD displays the low temperature alarm icon  . With 3 warning alerts, charging will be stopped.	Wait for the secondary battery pack to heat up, and resume charging only after the  icon appears.
15	Inverter Module High Temperature	The power station stops charging and discharging. The failure content is reported to APP. You can click "Alarm > Info" on the APP to view the specific fault content.	Stop the charging and discharging, and then using after cooling.
16	Internal Ambient High Temperature		Stop the charging and discharging, and then using after cooling.
17	PV High Temperature		Check whether the air duct and fan are abnormal.
18	Grid Frequency Abnormal		In this case, the Bypass mode is forbidden. Bypass: While the AC charging is in progress, the AC output is activated, but the battery does not power the AC output. If overload occurs in the bypass mode, the AC output will be turned off. Restart the power station to resume the AC output. The high instantaneous AC output power in the bypass mode may damage the power station.

7 Technical parameters

7.1 Technical parameters for main battery pack

Product model		ATZ3600EU
AC input	Rated AC input voltage	230VAC
	AC voltage range	200VAC to 240VAC
	Breakdown voltage	290VAC
	AC input frequency	50Hz/60Hz
	Rated AC input power	2300W
	Overload protection relay	Yes
DC input	Maximum withstand voltage at PV input terminal	60VDC
	PV controller type	MPPT
	MPPT maximum efficiency	≥99.5%
	MPPT voltage range	11VDC to 60VDC
	Number of MPPTs	1
	Maximum PV charging current	20A (when the PV input voltage is less than 30VDC, the maximum PV charging current is 10A)
	Maximum DC input power	1200W
Car charging	12VDC/10A	
AC output	Rated output power (@25°C)	3600W (2300W in bypass mode)
	3-second transient surge output power	5400W
	Output voltage level	230VAC±3%
	Output frequency level	It is 50 Hz in default, can be set to 60 Hz, error ± 0.2%
	Output voltage waveform	Pure sine wave
	Output voltage harmonic distortion	≤3% (pure resistive load)
DC output	USB-A output	5VDC/3A*2 (four USB-A interfaces (sharing a 5VDC/3A for every two interfaces))
	USB-C output	5VDC/3A (two USB-C interfaces (sharing a 5VDC/3A power supply))
	USB-C PD output	PD 100W * 2 (The protocol supports PD2.0, PD3.0, QC2.0, QC3.0, QC4+ and APPLE 5V/2.4A)

	Cigarette lighter output	12VDC/10A*2
Battery	Battery type	Lithium iron phosphate
	Rated voltage	51.2VDC
	Range of operating voltage	40.0VDC to 58.4VDC
	Range of operating temperature	Discharging: -20°C to 50°C; Charging: 0°C to 50°C
	Nominal capacity	2048Wh
Charging time	AC charging	1.2 hours
	Car charging	17 hours
	Solar charging (1200W input power)	1.7 hours
	AC charging plus maximum PV charging	1.2 hours
Others	Charging environment temperature	0°C to 40°C
	Discharging environment temperature	-20°C to 40°C (derating is required for use at greater than 35°C)
	Recommended working environment temperature	20°C to 35°C
	Storage environment temperature	1 month: -10°C to 50°C; 3 months: -10°C to 45°C; 6 months: -10°C to 30°C (high-temperature storage is not recommended; the storage time shall not exceed half a year, and it must be charged once every six months.)
	Relative humidity	<80%
	Altitude	<4000 meters (derating is required for operation at greater than 2000m)
	Protection degree	IP20
	Communication mode	Bluetooth
	Man-machine interface	Monochrome LCD, English interface
	External dimensions (length x width x height)	456x290x391mm (without secondary battery pack) 456x290x537mm (with secondary battery pack)
	Net weight	29.0kg (without secondary battery pack) 44.5Kg (with secondary battery pack)

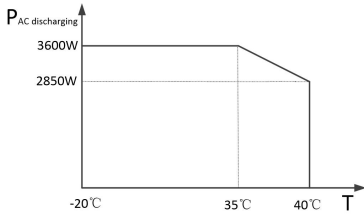

AC discharging power Vs temperature

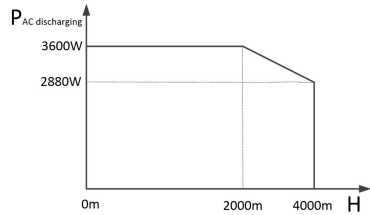

AC discharging power Vs altitude

7.2 Technical parameters for secondary battery pack

Product model		ATZ3600-BATT
Battery	Battery type	Lithium iron phosphate
	Rated voltage	51.2VDC
	Range of operating voltage	40.0VDC to 58.4VDC
	Range of operating temperature	Discharging: -20°C to 50°C; Charging: 0°C to 50°C
	Nominal capacity	2048Wh
Discharging	Rated discharging power	1000W
Charging	AC charging time	2.1 hours
	AC charging power	1000W
	Maximum MPPT input power	1000W
	MPPT voltage range	11VDC to 60VDC
	Maximum PV charging current	20A (when the PV input voltage is less than 30VDC, the maximum PV charging current is 10A)
	Solar charging time (1000W input power)	2.1 hours
Others	Charging environment temperature	0°C to 40°C
	Discharging environment temperature	-20°C to 40°C
	Recommended working environment temperature	20°C to 35°C

Storage environment temperature	1 month: -10°C to 50°C; 3 months: -10°C to 45°C; 6 months: -10°C to 30°C (high-temperature storage is not recommended; the storage time shall not exceed half a year, and it must be charged once every six months.)
Relative humidity	<80%
Altitude	<4000 meters
Protection degree	IP20
External dimensions (length x width x height)	428x196x224.4mm
Net weight	15.5kg

All the technical parameters are subject to change without notice. Version No.: V1.0

HUIZHOU EPEVER TECHNOLOGY CO., LTD.

Tel: +86-752-3889706

E-mail: info@epever.com

Website: www.epever.com